

# Storage & Hardware



## Drop In Ice Well with Raised Flange

### ICEDI-303020

(300mm x 300mm x 200mm)

- Internal skin - constructed from 1.2mm 304 Grade Stainless Steel
- External skin - constructed from 1.2mm 304 Grade Stainless Steel complete with a raised flange to prevent cross contamination
- Radius corners and cross breaks to a 25mm centre waste
- 25mm urethane injected insulation
- Ice lid and basket available (optional)
- Custom sizes available, custom made products incur a lead time

Top

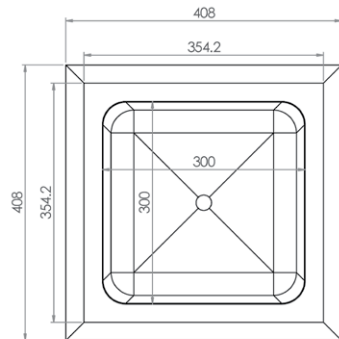

Side

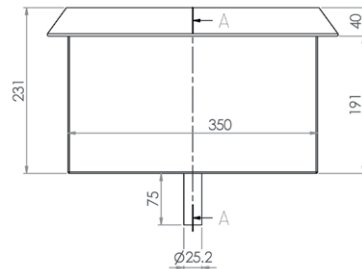

Cross Section

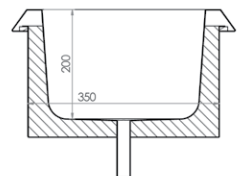

ICEL-303020  
ICEB-303020

